



*Table de pédiatrie fixe*

**PEDIA04T**

**CARINA**  
*Medical*



**CE**  
ISO 9001  
ISO 13485

## DESCRIPTION TECHNIQUE

- Table de pédiatrie à hauteur fixe
- Sellerie tendue plate de bonne densité 24kg/cm<sup>2</sup>, non-feu classée M1, épaisseur 5cm, avec rebords densité 34kg/cm<sup>2</sup> sur 3 côtés
- Equipé d'un porte-rouleau pour drap d'examen et d'un plateau inférieur
- Piètement acier peint époxy, coloris gris clair (RAL 7035) en standard

## DIMENSIONS

- Largeur 100cm
- Profondeur 72cm
- Hauteur 86cm
- Capacité de charge : 80kg

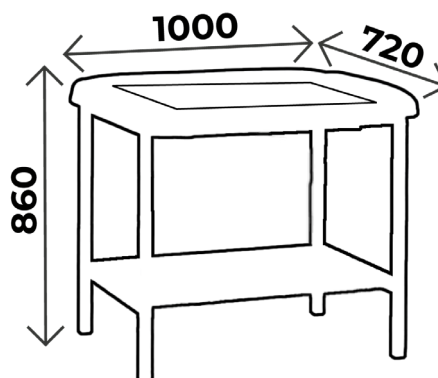

## ACCESSOIRE



**ACC 990**  
Jeu de 4 roulettes à frein  
diam. 125mm

### Vous aimerez aussi :

Réf. **PEDIA03T** : Idem PEDIA04T mais sans plateau inférieur

Réf. **PEDIA05T** : Idem PEDIA04T mais avec tiroir 600x400 et sans plateau inférieur

Réf. **PEDIA06T** : Idem PEDIA04T mais avec tiroir 600x400



## À SAVOIR

- ✓ Délai : 15 jours à réception commande
- ✓ Garantie : 2 ans (1 an pour la sellerie)

# COLORIS SELLERIE

Sellerie non-feu  
classée M1

Pour les coloris de sellerie, vous avez le choix entre la gamme Classique et Urban  
Attention ! coloris Classique et Urban avec **plus value**

## *Revêtement : Sellerie Gamme Classique*



Arno



Garonne



Potomac

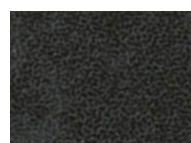

Amour



Mississippi

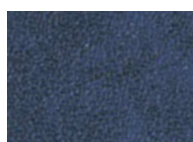

St Laurent



Rhône

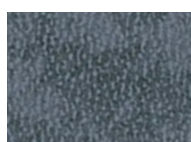

Missouri



Seine

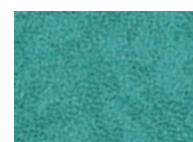

Amazone

## *Revêtement : Sellerie Gamme Urban*



Abysse

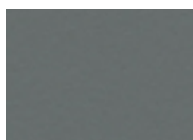

Cendre



Origan

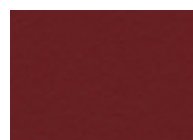

Géranium



Réglisse



Prune

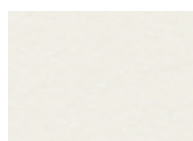

Perle

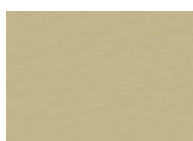

Ficelle

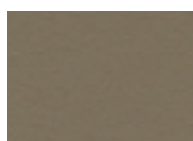

Terre

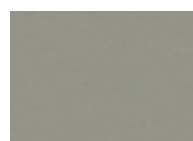

Béton

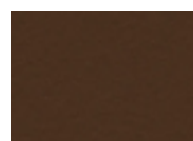

Chataigne

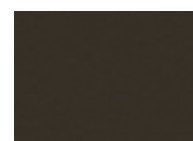

Chocolat



Pensée



Pétrole



Turquoise



Granny



Absinthe



Ananas



Orange



Fuschia



Tomate

# COLORIS PIÈTEMENT

La table PEDIA04T a un piètement coloris gris clair (RAL 7035) en standard  
Possibilité de changer le coloris **sans plus value**

## *Piètement Peinture EPOXY*

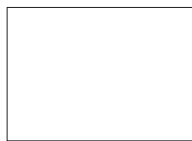

RAL 9003

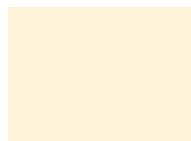

RAL 1013

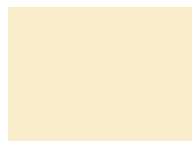

RAL 1015

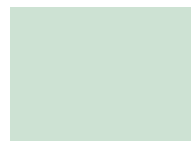

RAL 6019



RAL 6033



RAL 6000



RAL 5017



RAL 5002



RAL 5000

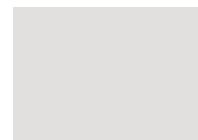

RAL 7035



RAL 7016

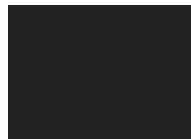

RAL 9005



RAL 1018



RAL 3020



RAL 3003



ARGENT



## GUIDE D'ENTRETIEN

### ENTRETIEN QUOTIDIEN

- Sellerie : nettoyage à l'eau savonneuse uniquement (solvants proscrits), peut être désinfecté avec des produits tels que Phagosept Spray, Salvanios pH10 à 0,75% et Anios Surfaces Hautes, sans matière abrasive
- Piètement : nettoyage à l'eau savonneuse uniquement (solvants proscrits) sans matière abrasive

### GARANTIE

- Châssis : 2 ans
- Sellerie : 1 an



**CONTACT**

**CARINA**  
*Médical*

Parc d'entreprises Visionis  
278 rue de l'industrie  
01090 GUÉREINS- FRANCE

**SERVICE COMMERCIAL**

Tél : +33(0)4 74 66 69 49  
Fax : +33(0)4 74 66 69 50  
[commercial@carinamedical.com](mailto:commercial@carinamedical.com)